

Coaxial Terminations

Part Number: **CT50-2-L1-3**

Electrical Specifications

- ✧ **Nominal Impedance:** 50 Ω
- ✧ **Power Rating:** 2W
- ✧ **Frequency:** DC-3GHz
- ✧ **VSWR (Max.):** 1.20:1
- ✧ **Connector Type:** L29(Male)
- ✧ **Operating Temperature:** -55°C to +85°C
- ✧ **Dimension:** Φ30*40.8mm
- ✧ **Tolerance:** ±2%
- ✧ **Net Weight:** 110g
- ✧ **RoHS Compliant**

Outline Drawing (mm)

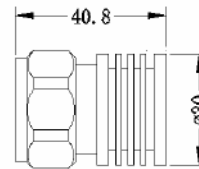

HOW TO ORDER

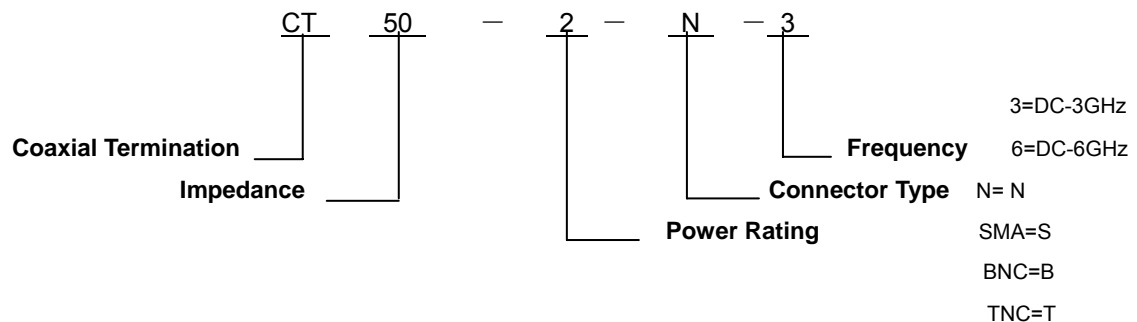

Coaxial Terminations

Part Number: **CT50-2-L1-6**

Electrical Specifications

- ✧ **Nominal Impedance:** 50 Ω
- ✧ **Power Rating:** 2W
- ✧ **Frequency:** DC-6GHz
- ✧ **VSWR (Max.):** 1.30:1
- ✧ **Connector Type:** L29(Male)
- ✧ **Operating Temperature:** -55°C to +85°C
- ✧ **Dimension:** Φ30*40.8mm
- ✧ **Tolerance:** ±2%
- ✧ **Net Weight:** 110g
- ✧ **RoHS Compliant**

Outline Drawing (mm)

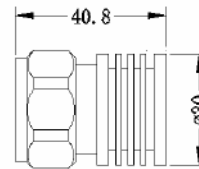

HOW TO ORDER

