

**Coaxial Terminations**

**Part Number: CT50-5-N1-3**

**Electrical Specifications**

- ✧ **Nominal Impedance:** 50 Ω
- ✧ **Power Rating:** 5W
- ✧ **Frequency:** DC-3GHz
- ✧ **VSWR (Max.):** 1.20:1
- ✧ **Connector Type:** N(Male)
- ✧ **Operating Temperature:** -55°C to +85°C
- ✧ **Dimension:** Φ20\*36mm
- ✧ **Tolerance:** ±2%
- ✧ **Net Weight:** 33g
- ✧ **RoHS Compliant**

**Outline Drawing (mm)**

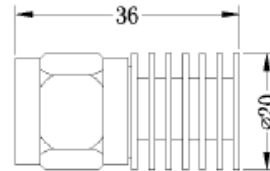

**HOW TO ORDER**

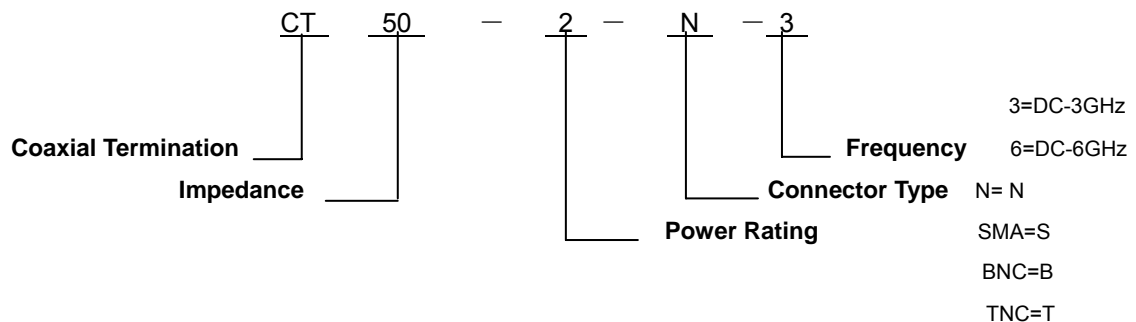

**Coaxial Terminations**

**Part Number: CT50-5-N1-6**

**Electrical Specifications**

- ✧ **Nominal Impedance:** 50 Ω
- ✧ **Power Rating:** 5W
- ✧ **Frequency:** DC-6GHz
- ✧ **VSWR (Max.):** 1.30:1
- ✧ **Connector Type:** N(Male)
- ✧ **Operating Temperature:** -55°C to +85°C
- ✧ **Dimension:** Φ20\*36mm
- ✧ **Tolerance:** ±2%
- ✧ **Net Weight:** 33g
- ✧ **RoHS Compliant**

**Outline Drawing (mm)**

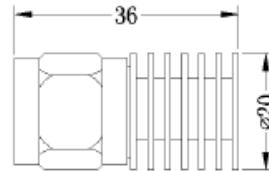

**HOW TO ORDER**

