

**Coaxial Attenuators**

**Part Number: CA2-XX-N2-3**

**Electrical Specifications**

- ✧ **Nominal Impedance:** 50 Ω
- ✧ **Power Rating:** 2W
- ✧ **Frequency:** DC-3GHz
- ✧ **VSWR (Max.):** 1.20:1
- ✧ **Attenuation & Tol. :**
  - 1-10dB ±0.6dB
  - 11-20dB ±0.8dB
  - 21-30dB ±1.0dB
- ✧ **Connector Type:** N(Male/Female)
- ✧ **Operating Temperature:** -55℃ to +85℃
- ✧ **Dimension:** Φ20\*48mm
- ✧ **Tolerance:** ±2%
- ✧ **Net Weight:** 51g
- ✧ **RoHS Compliant**

**Outline Drawing (mm)**

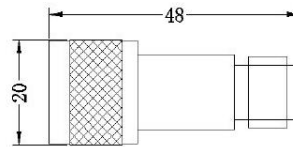

**HOW TO ORDER**

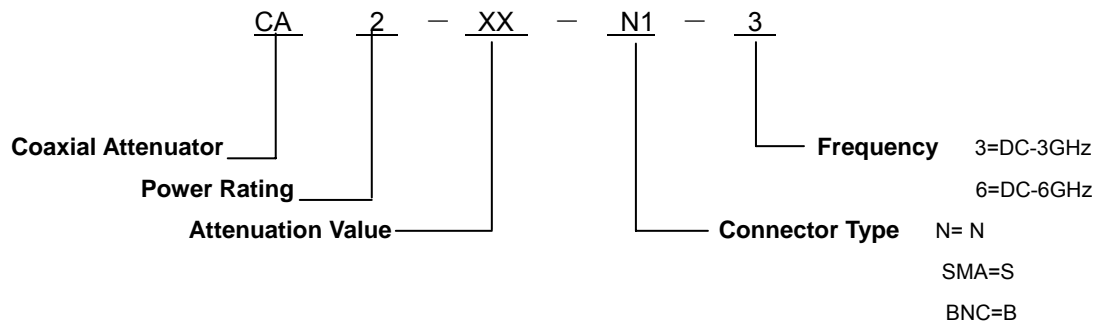

**Coaxial Attenuators**

**Part Number: CA2-XX-N2-8**

**Electrical Specifications**

- ✧ **Nominal Impedance:** 50 Ω
- ✧ **Power Rating:** 2W
- ✧ **Frequency:** DC-8GHz
- ✧ **VSWR (Max.):** 1.30:1
- ✧ **Attenuation & Tol. :**
  - 1-10dB ±0.6dB
  - 11-20dB ±0.8dB
  - 21-30dB ±1.0dB
- ✧ **Connector Type:** N(Male/Female)
- ✧ **Operating Temperature:** -55°C to +85°C
- ✧ **Dimension:** Φ20\*48mm
- ✧ **Tolerance:** ±2%
- ✧ **Net Weight:** 51g
- ✧ **RoHS Compliant**

**Outline Drawing (mm)**

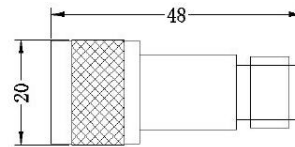

**HOW TO ORDER**

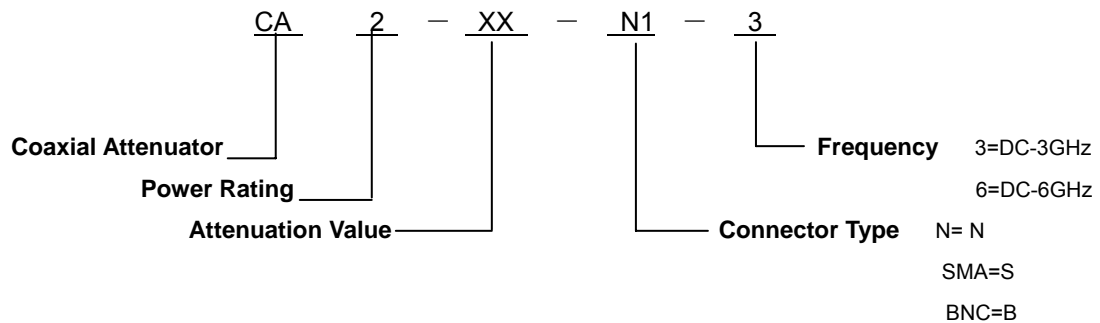

**Coaxial Attenuators**

**Part Number: CA2-XX-N2-12.4**

**Electrical Specifications**

- ✧ **Nominal Impedance:** 50 Ω
- ✧ **Power Rating:** 2W
- ✧ **Frequency:** DC-12.4GHz
- ✧ **VSWR (Max.):** 1.40:1
- ✧ **Attenuation & Tol. :**
  - 1-10dB ±0.8dB
  - 11-20dB ±1.0dB
  - 21-30dB ±1.1dB
- ✧ **Connector Type:** N(Male/Female)
- ✧ **Operating Temperature:** -55°C to +85°C
- ✧ **Dimension:** Φ20\*48mm
- ✧ **Tolerance:** ±2%
- ✧ **Net Weight:** 51g
- ✧ **RoHS Compliant**

**Outline Drawing (mm)**

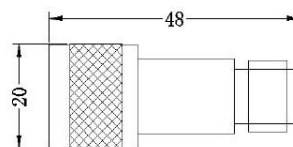

**HOW TO ORDER**

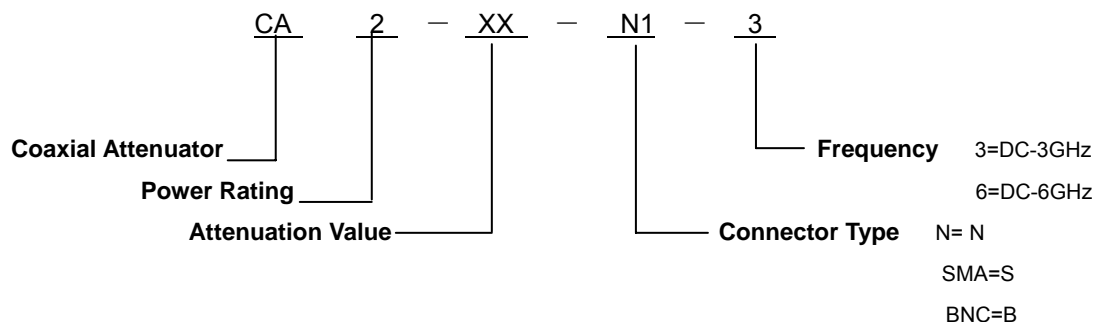

**Coaxial Attenuators**

**Part Number: CA2-XX-N2-18**

**Electrical Specifications**

- ✧ **Nominal Impedance:** 50 Ω
- ✧ **Power Rating:** 2W
- ✧ **Frequency:** DC-18GHz
- ✧ **VSWR (Max.):** 1.45:1
- ✧ **Attenuation & Tol. :**
  - 1-10dB ±0.8dB
  - 11-20dB ±1.0dB
  - 21-30dB ±1.1dB
- ✧ **Connector Type:** N(Male/Female)
- ✧ **Operating Temperature:** -55℃ to +85℃
- ✧ **Dimension:** Φ20\*48mm
- ✧ **Tolerance:** ±2%
- ✧ **Net Weight:** 51g
- ✧ **RoHS Compliant**

**Outline Drawing (mm)**

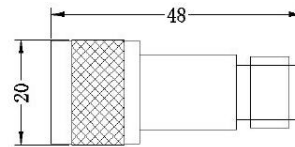

**HOW TO ORDER**

