

Coaxial Attenuators

Part Number: CA25-XX-N2-3

Electrical Specifications

- ✧ **Nominal Impedance:** 50 Ω
- ✧ **Power Rating:** 25W
- ✧ **Frequency:** DC-3GHz
- ✧ **VSWR (Max.):** 1.20:1
- ✧ **Attenuation & Tol. :**
 - 1-10dB ±0.6dB
 - 11-20dB ±0.8dB
 - 21-30dB ±1.0dB
- ✧ **Connector Type:** N(Male/Female)
- ✧ **Operating Temperature:** -55°C to +85°C
- ✧ **Dimension:** Φ45*68mm
- ✧ **Tolerance:** ±2%
- ✧ **Net Weight:** 105g
- ✧ **RoHS Compliant**

Outline Drawing (mm)

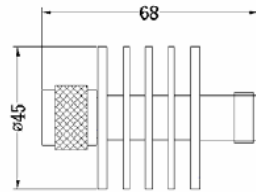

HOW TO ORDER

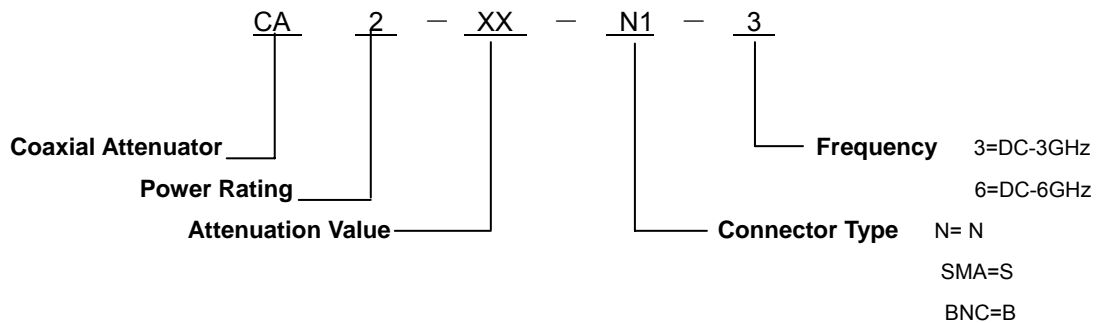

Coaxial Attenuators

Part Number: CA25-XX-N2-8

Electrical Specifications

- ✧ **Nominal Impedance:** 50 Ω
- ✧ **Power Rating:** 25W
- ✧ **Frequency:** DC-8GHz
- ✧ **VSWR (Max.):** 1.30:1
- ✧ **Attenuation & Tol. :**
 - 1-10dB ±0.7dB
 - 11-20dB ±0.9dB
 - 21-30dB ±1.0dB
- ✧ **Connector Type:** N(Male/Female)
- ✧ **Operating Temperature:** -55°C to +85°C
- ✧ **Dimension:** Φ45*68mm
- ✧ **Tolerance:** ±2%
- ✧ **Net Weight:** 105g
- ✧ **RoHS Compliant**

Outline Drawing (mm)

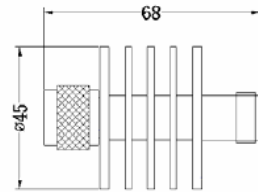

HOW TO ORDER

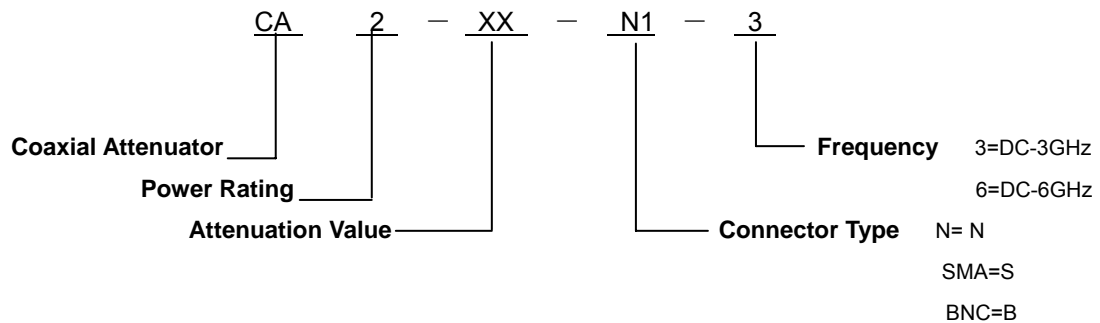

Coaxial Attenuators

Part Number: CA25-XX-N2-12.4

Electrical Specifications

- ✧ **Nominal Impedance:** 50 Ω
- ✧ **Power Rating:** 25W
- ✧ **Frequency:** DC-12.4GHz
- ✧ **VSWR (Max.):** 1.40:1
- ✧ **Attenuation & Tol. :**
 - 1-10dB ±0.9dB
 - 11-20dB ±1.1dB
 - 21-30dB ±1.2dB
- ✧ **Connector Type:** N(Male/Female)
- ✧ **Operating Temperature:** -55°C to +85°C
- ✧ **Dimension:** Φ45*68mm
- ✧ **Tolerance:** ±2%
- ✧ **Net Weight:** 105g
- ✧ **RoHS Compliant**

Outline Drawing (mm)

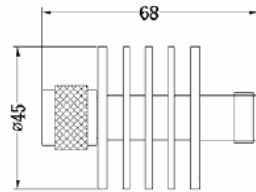

HOW TO ORDER

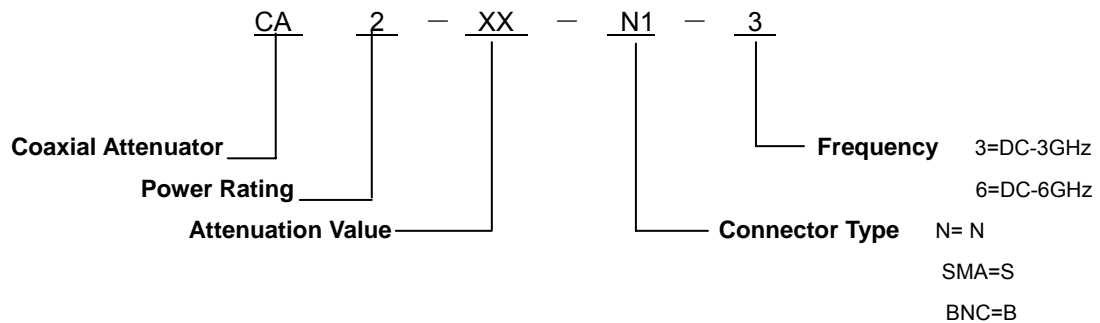

Coaxial Attenuators

Part Number: CA25-XX-N2-18

Electrical Specifications

- ✧ **Nominal Impedance:** 50 Ω
- ✧ **Power Rating:** 25W
- ✧ **Frequency:** DC-18GHz
- ✧ **VSWR (Max.):** 1.45:1
- ✧ **Attenuation & Tol. :**
 - 1-10dB ±0.9dB
 - 11-20dB ±1.1dB
 - 21-30dB ±1.2dB
- ✧ **Connector Type:** N(Male/Female)
- ✧ **Operating Temperature:** -55°C to +85°C
- ✧ **Dimension:** Φ45*68mm
- ✧ **Tolerance:** ±2%
- ✧ **Net Weight:** 105g
- ✧ **RoHS Compliant**

Outline Drawing (mm)

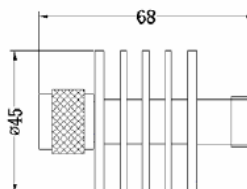

HOW TO ORDER

