

Broadband Coaxial Isolators

Part Number: KTBI-1201A

Main Features:

- Broad Frequency Range: 8-18GHz, Bandwidth up to Full
- High Isolation, Low Insertion Loss, High Power Handling
- Wide Operating Temperature: -40°C~+70°C
- Commercial, Military and Space Applications

Electrical Specifications at Room Temperature:

Part Number	Freq. Range (GHz)	Bandwidth Max. (MHz)	Insertion Loss Max. (dB)	Isolation Min. (dB)	VSWR Max.	Reverse Power (W)	Connector Type
KTBI-1201A	8 - 18	full	0.8	17	1.40	5	SMA

Mechanical Dimensions (mm):

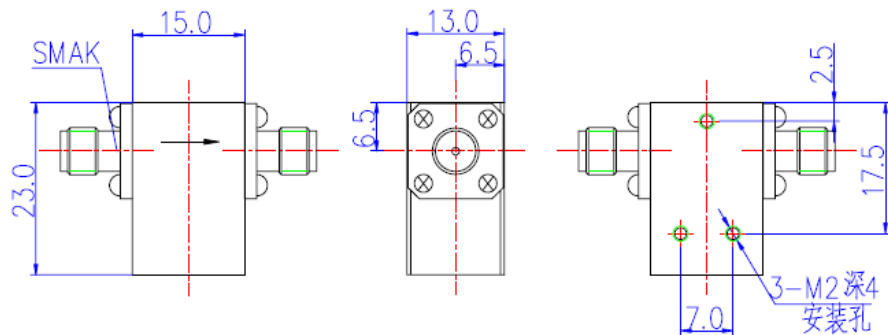

HOW TO ORDER

