

Coaxial Isolators

Part Number: KTCI-0301B

Main Features:

- Frequency Range: 0.25GHz - 0.45GHz
- Small Size, High Isolation, Low Insertion Loss, High Power Handling
- Wide Operating Temperature: -15°C~+60°C
- Commercial, Military and Space Applications

Electrical Specifications at Room Temperature:

Part Number	Freq. Range (GHz)	Bandwidth Max. (MHz)	Insertion Loss Max. (dB)	Isolation Min. (dB)	VSWR Max.	Reverse Power (W)	Connector Type
KTCI-0301B	0.25 - 0.45	30	0.4	20	1.25	100	SMA/N

Mechanical Dimensions (mm):

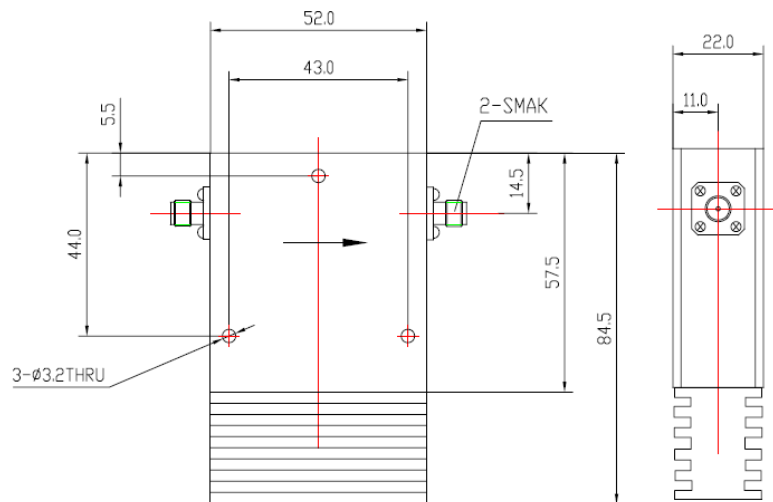

HOW TO ORDER

