

Drop-in Isolators

Part Number: KTDI102M3-10

Main Features:

- Frequency Range: 1.2GHz - 3.8GHz
- High Isolation, Low Insertion Loss, Small Size
- Wide Operating Temperature: -40°C~+85°C
- Commercial, Military and Space Applications

Electrical Specifications at Room Temperature:

Part Number	Freq. Range (GHz)	Bandwidth Max. (MHz)	Insertion Loss Max. (dB)	Isolation Min. (dB)	VSWR Max.	Reverse Power (W)	Connector Type
KTDI102M3-10	1.2 - 3.8	100	0.4	23	1.20	10	TAB

Mechanical Dimensions (mm):

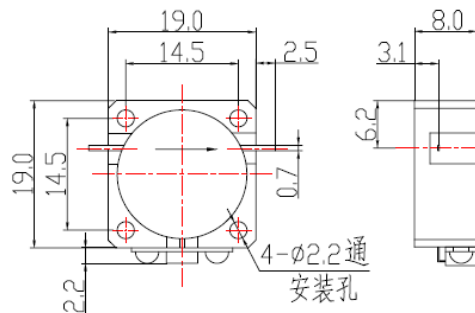

HOW TO ORDER

