

## Waveguide Isolators

Part Number: KTWI220-12.7

### Main Features:

- Broad Frequency Range: 17.6 GHz -26.7GHz
- High Isolation, Low Insertion Loss, Small Size
- Wide Operating Temperature: -40°C~+85°C
- Commercial, Military and Space Applications

### Electrical Specifications at Room Temperature:

Part Number	Freq. Range (GHz)	Bandwidth Max. (MHz)	Insertion Loss Max. (dB)	Isolation Min. (dB)	VSWR Max.	Waveguide Type
KTWI220-12.7	17.6 - 26.7	500	0.3	25	1.15	WR42
KTWI220-12.7	17.6 - 26.7	1000	0.3	23	1.20	WR42
KTWI220-12.7	17.6 - 26.7	2000	0.4	20	1.20	WR42

### Mechanical Dimensions (mm):

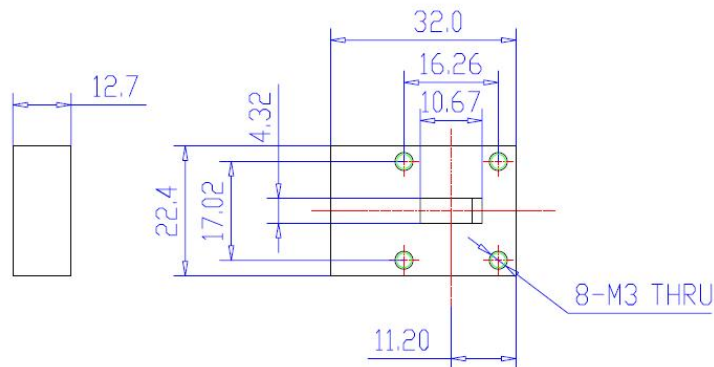

### HOW TO ORDER

