

Waveguide Isolators

Part Number: KTWI400-10

Main Features:

- Broad Frequency Range: 33.0GHz - 50.1GHz
- High Isolation, Low Insertion Loss, Small Size
- Wide Operating Temperature: -40°C~+85°C
- Commercial, Military and Space Applications

Electrical Specifications at Room Temperature:

Part Number	Freq. Range (GHz)	Bandwidth Max. (MHz)	Insertion Loss Max. (dB)	Isolation Min. (dB)	VSWR Max.	Waveguide Type
KTWI400-10	33.0 - 50.1	1000	0.3	23	1.20	WR22
KTWI400-10	33.0 - 50.1	2000	0.4	20	1.25	WR22

Mechanical Dimensions (mm):

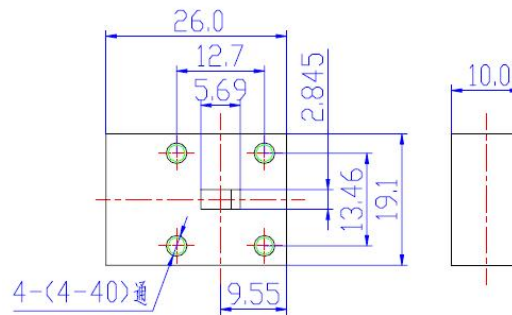

HOW TO ORDER

