

Surface Mount Circulators

Part Number: KTSC-202S05

Main Features:

- Frequency Range: 1.8 - 2.7GHz
- High Isolation, Low Insertion Loss, Small Size
- Wide Operating Temperature: -40°C ~+85°C
- Commercial, Military and Space Applications

Electrical Specifications at Room Temperature:

Part Number	Freq. Range (GHz)	Relative Bandwidth	Insertion Loss Max. (dB)	Isolation Min. (dB)	VSWR Max.	Connector Type
KTSC-202S05	1.8 - 2.7	5%	0.4	20	1.25	SMD

Mechanical Dimensions (mm):

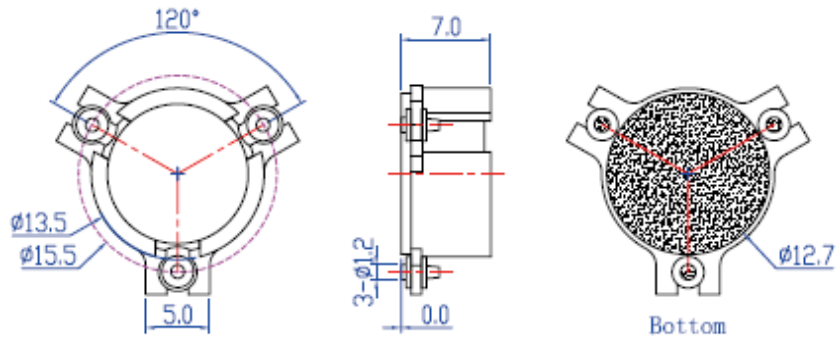

HOW TO ORDER

