

## Surface Mount Isolators

Part Number: KTSI102M1-4

### Main Features:

- Frequency Range: 0.5 - 1.0GHz
- High Isolation, Low Insertion Loss, Small Size, High Power
- Wide Operating Temperature: -40°C ~+85°C
- Commercial, Military and Space Applications

### Electrical Specifications at Room Temperature:

Part Number	Freq. Range (GHz)	Relative Bandwidth	Insertion Loss Max. (dB)	Isolation Min. (dB)	VSWR Max.	Load Power (W)	Connector Type
KTSI102M1-4	0.5 - 1.0	5%	0.5	23	1.20	10	SMD

### Mechanical Dimensions (mm):

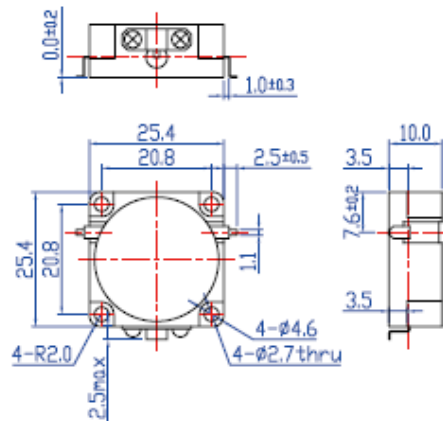

### HOW TO ORDER

