

Surface Mount Isolators

Part Number: KTSI202S08-100

Main Features:

- Frequency Range: 1.2 - 3.8GHz
- High Isolation, Low Insertion Loss, Small Size, High Power
- Wide Operating Temperature: -40°C ~+85°C
- Commercial, Military and Space Applications

Electrical Specifications at Room Temperature:

Part Number	Freq. Range (GHz)	Relative Bandwidth	Insertion Loss Max. (dB)	Isolation Min. (dB)	VSWR Max.	Load Power (W)	Connector Type
KTSI202S08-100	1.2 - 3.8	5%	0.4	23	1.20	100	SMD

Mechanical Dimensions (mm):

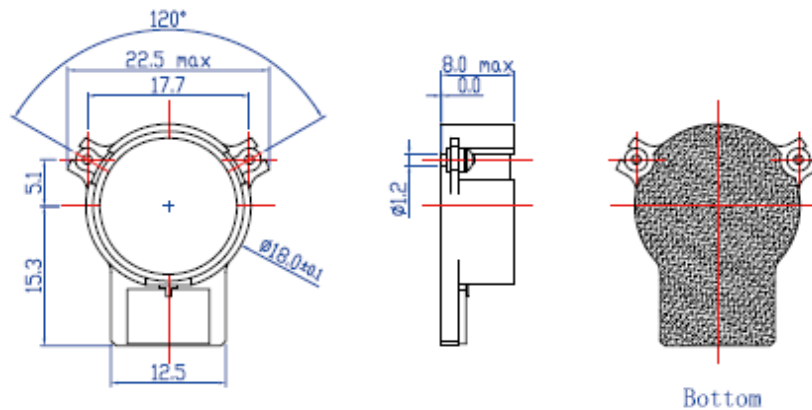

HOW TO ORDER

