

Microstrip Circulator

Part Number: KTMC-902A3

Main Features:

- Frequency Range: 8GHz - 12GHz
- Small Size, Thin Film Technology
- High Isolation, Low Insertion Loss
- Wide Operating Temperature : -55°C~+85°C
- Commercial, Military and Space Applications

Electrical Specifications at Room Temperature:

Part Number	Freq. Range (GHz)	Bandwidth Max. (MHz)	Insertion Loss Max. (dB)	Isolation Min. (dB)	VSWR Max.	Connector Type
KTMC-902A3	8 - 12	full	0.6	17	1.35	GWB

Mechanical Dimensions (mm):

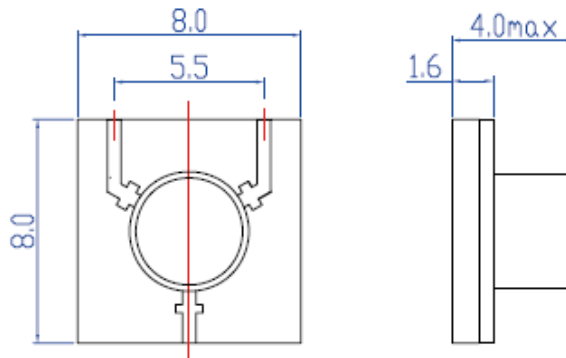

HOW TO ORDER

