

## Microstrip Dual Junction Circulator

Part Number: KTMC-502AS5

### Main Features:

- Frequency Range: 5.1GHz - 5.7GHz
- Small Size, Thin Film Technology
- High Isolation, Low Insertion Loss
- Wide Operating Temperature : -55°C~+85°C
- Commercial, Military and Space Applications

### Electrical Specifications at Room Temperature:

Part Number	Freq. Range (GHz)	Bandwidth Max. (MHz)	Insertion Loss Max. (dB)	Isolation Min. (dB)	VSWR Max.	Load Power (W)	Connector Type
KTMC-502AS5	5.1 - 5.7	full	0.5(2→3) 1.0(3→1)	20(3→2) 38(1→3)	1.3	10	GWB

### Mechanical Dimensions (mm):

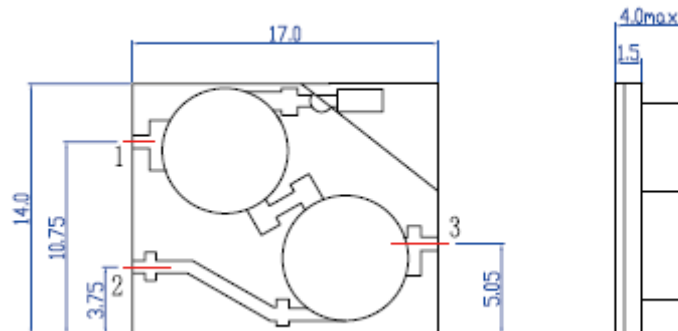

### HOW TO ORDER

