

Microstrip Dual Junction Circulator

Part Number: KTMC-1202AS1

Main Features:

- Frequency Range: 11.5GHz - 13.5GHz
- Small Size, Thin Film Technology
- High Isolation, Low Insertion Loss
- Wide Operating Temperature : -55°C~+85°C
- Commercial, Military and Space Applications

Electrical Specifications at Room Temperature:

Part Number	Freq. Range (GHz)	Bandwidth Max. (MHz)	Insertion Loss Max. (dB)	Isolation Min. (dB)	VSWR Max.	Load Power (W)	Connector Type
KTMC-1202AS1	11.5 - 13.5	full	0.6(1→2) 1.1(2→3)	18(2→1) 30(3→2)	1.30	10	GWB

Mechanical Dimensions (mm):

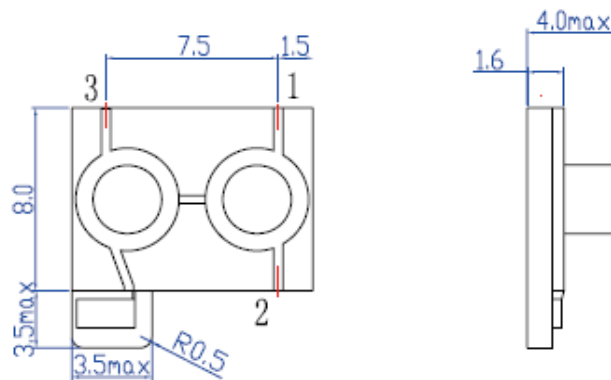

HOW TO ORDER

