

Dual Junction Drop-in Circulators

Part Number: KTDC-102MS

Key Features

- Frequency Range: 0.8GHz-2.2GHz
- Low Insertion Loss, High Isolation
- High Power, Good Performance
- Wide Operating Temperature Range : -40°C~+85°C
- Commercial, Military and Space Applications

Electrical Specifications at Room (25°C±5°C) Temperature

Part Number	Freq. Range (GHz)	Bandwidth Max. (MHz)	Insertion Loss Max. (dB)	Isolation Min. (dB)	VSWR Max.	Forward Power (W)	Connector Type
KTDC-102MS	0.8 - 2.2	70	0.6	46	1.20	100	TAB

Mechanical Dimensions (mm)

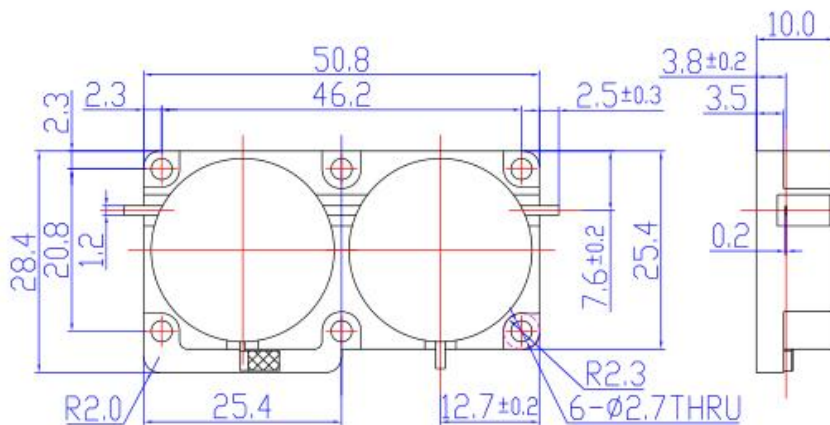

HOW TO ORDER

