

Microstrip Isolators

Part Number: KTMI-2602A2

Key Features

- Frequency Range: 24.5GHz-28.35GHz
- Good Consistency
- Small Size, High Precision
- High Isolation, Low Insertion Loss
- Wide Operating Temperature Range: -55°C~+85°C
- Widely Used in Various Millimeter Wave Radar & TR Components

Electrical Specifications at Room (25°C±5°C) Temperature

Part Number	Freq. Range (GHz)	Bandwidth Max. (MHz)	Insertion Loss Max. (dB)	Isolation Min. (dB)	VSWR Max.	Reverse Power (W)	Connector Type
KTMI-2602A2	24.5 - 28.35	full	1.2	18	1.40	0.5	GWB

Mechanical Dimensions (mm)

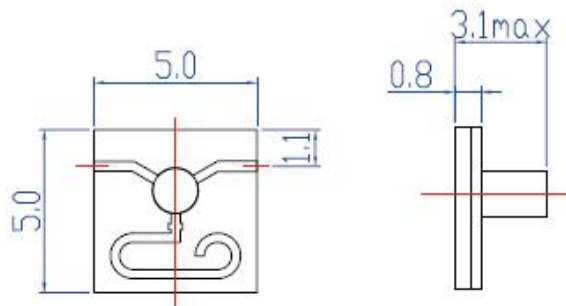

HOW TO ORDER

