

## Microstrip Isolators

Part Number: KTMI-502A5

### Key Features

- Frequency Range: 5.0GHz-6.0GHz
- Good Consistency
- Small Size, High Precision
- High Isolation, Low Insertion Loss
- Wide Operating Temperature Range: -55°C~+85°C
- Widely Used in Various Millimeter Wave Radar & TR Components

### Electrical Specifications at Room (25°C±5°C) Temperature

Part Number	Freq. Range (GHz)	Bandwidth Max. (MHz)	Insertion Loss Max. (dB)	Isolation Min. (dB)	VSWR Max.	Reverse Power (W)	Connector Type
KTMI-502A5	5.0 - 6.0	full	0.5	18	1.25	10	GWB

### Mechanical Dimensions (mm)

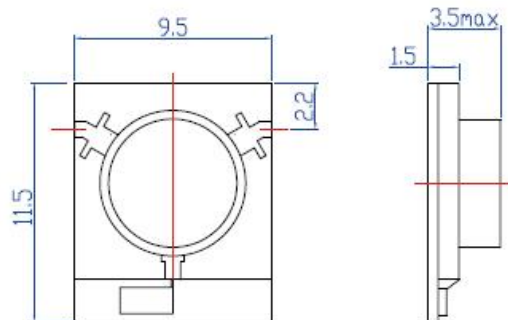

### HOW TO ORDER

