

Microstrip Isolators

Part Number: KTMI-902A19

Key Features

- Frequency Range: 8GHz-12GHz
- Good Consistency
- Small Size, High Precision
- High Isolation, Low Insertion Loss
- Wide Operating Temperature Range: -55°C~+85°C
- Widely Used in Various Millimeter Wave Radar & TR Components

Electrical Specifications at Room (25°C±5°C) Temperature

Part Number	Freq. Range (GHz)	Bandwidth Max. (MHz)	Insertion Loss Max. (dB)	Isolation Min. (dB)	VSWR Max.	Reverse Power (W)	Connector Type
KTMI-902A19	8 - 12	full	0.6	17	1.35	10	GWB

Mechanical Dimensions (mm)

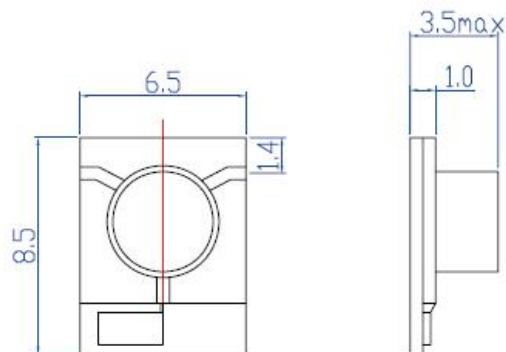

HOW TO ORDER

